

General Description

The GreenMOS[®] high voltage MOSFET utilizes charge balance technology to achieve outstanding low on-resistance and lower gate charge. It is engineered to minimize conduction loss, provide superior switching performance and robust avalanche capability.

The GreenMOS[®] Z series is integrated with fast recovery diode (FRD) to minimize reverse recovery time. It is suitable for resonant switching topologies to reach higher efficiency, higher reliability and smaller form factor.

Features

- Low $R_{DS(ON)}$ & FOM
- Extremely low switching loss
- Excellent stability and uniformity
- Ultra-fast and robust body diode

Applications

- PC power
- Telecom power
- Server power
- EV Charger
- Motor driver





Key Performance Parameters

| Parameter | Value | Unit |
|--------------------------------|-------|------------|
| $V_{DS, min} @ T_{j(max)}$ | 650 | V |
| $I_D, pulse$ | 90 | A |
| $R_{DS(ON), max} @ V_{GS}=10V$ | 108 | m Ω |
| Q_g | 56.7 | nC |

Marking Information

| Product Name | Package | Marking |
|---------------|---------|--------------|
| OSG60R108HSZF | TO247 | OSG60R108HSZ |

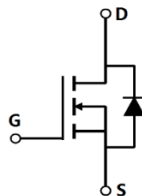
Package & Pin Information



Absolute Maximum Ratings at $T_j=25^\circ\text{C}$ unless otherwise noted

| Parameter | Symbol | Value | Unit |
|---|----------------|------------|------------------|
| Drain-source voltage | V_{DS} | 600 | V |
| Gate-source voltage | V_{GS} | ± 30 | V |
| Continuous drain current ¹⁾ , $T_C=25^\circ\text{C}$ | I_D | 30 | A |
| Continuous drain current ¹⁾ , $T_C=100^\circ\text{C}$ | | 19 | |
| Pulsed drain current ²⁾ , $T_C=25^\circ\text{C}$ | $I_{D, pulse}$ | 90 | A |
| Continuous diode forward current ¹⁾ , $T_C=25^\circ\text{C}$ | I_S | 30 | A |
| Diode pulsed current ²⁾ , $T_C=25^\circ\text{C}$ | $I_{S, pulse}$ | 90 | A |
| Power dissipation ³⁾ , $T_C=25^\circ\text{C}$ | P_D | 219 | W |
| Single pulsed avalanche energy ⁵⁾ | E_{AS} | 1000 | mJ |
| MOSFET dv/dt ruggedness, $V_{DS}=0\dots 480\text{ V}$ | dv/dt | 50 | V/ns |
| Reverse diode dv/dt, $V_{DS}=0\dots 480\text{ V}$, $I_{SD}\leq I_D$ | dv/dt | 50 | V/ns |
| Operation and storage temperature | T_{stg}, T_j | -55 to 150 | $^\circ\text{C}$ |

Thermal Characteristics

| Parameter | Symbol | Value | Unit |
|--|-----------------|-------|--------------------|
| Thermal resistance, junction-case | $R_{\theta JC}$ | 0.57 | $^\circ\text{C/W}$ |
| Thermal resistance, junction-ambient ⁴⁾ | $R_{\theta JA}$ | 62 | $^\circ\text{C/W}$ |

Electrical Characteristics at $T_j=25^\circ\text{C}$ unless otherwise specified

| Parameter | Symbol | Min. | Typ. | Max. | Unit | Test condition |
|----------------------------------|--------------|------|-------|-------|---------------|---|
| Drain-source breakdown voltage | BV_{DSS} | 600 | | | V | $V_{GS}=0\text{ V}$, $I_D=1\text{ mA}$ |
| | | 650 | | | | $V_{GS}=0\text{ V}$, $I_D=1\text{ mA}$, $T_j=150^\circ\text{C}$ |
| Gate threshold voltage | $V_{GS(th)}$ | 3.0 | | 4.5 | V | $V_{DS}=V_{GS}$, $I_D=1\text{ mA}$ |
| Drain-source on-state resistance | $R_{DS(on)}$ | | 0.085 | 0.108 | Ω | $V_{GS}=10\text{ V}$, $I_D=15\text{ A}$ |
| | | | 0.20 | | | $V_{GS}=10\text{ V}$, $I_D=15\text{ A}$, $T_j=150^\circ\text{C}$ |
| Gate-source leakage current | I_{GSS} | | | 100 | nA | $V_{GS}=30\text{ V}$ |
| | | | | -100 | | $V_{GS}=-30\text{ V}$ |
| Drain-source leakage current | I_{DSS} | | | 10 | μA | $V_{DS}=600\text{ V}$, $V_{GS}=0\text{ V}$ |

Dynamic Characteristics

| Parameter | Symbol | Min. | Typ. | Max. | Unit | Test condition |
|------------------------------|--------------|------|--------|------|------|---|
| Input capacitance | C_{iss} | | 2878.2 | | pF | $V_{GS}=0\text{ V}$, $V_{DS}=50\text{ V}$, $f=100\text{ KHz}$ |
| Output capacitance | C_{oss} | | 226.7 | | pF | |
| Reverse transfer capacitance | C_{rss} | | 8.3 | | pF | |
| Turn-on delay time | $t_{d(on)}$ | | 56.8 | | ns | $V_{GS}=10\text{ V}$, $V_{DS}=400\text{ V}$, $R_G=2\ \Omega$, $I_D=16\text{ A}$ |
| Rise time | t_r | | 63.1 | | ns | |
| Turn-off delay time | $t_{d(off)}$ | | 116.1 | | ns | |
| Fall time | t_f | | 7.1 | | ns | |

Gate Charge Characteristics

| Parameter | Symbol | Min. | Typ. | Max. | Unit | Test condition |
|----------------------|---------------|------|------|------|------|--|
| Total gate charge | Q_g | | 56.7 | | nC | $V_{GS}=10\text{ V}$, $V_{DS}=400\text{ V}$, $I_D=16\text{ A}$ |
| Gate-source charge | Q_{gs} | | 14.2 | | nC | |
| Gate-drain charge | Q_{gd} | | 27.2 | | nC | |
| Gate plateau voltage | $V_{plateau}$ | | 7.0 | | V | |

Body Diode Characteristics

| Parameter | Symbol | Min. | Typ. | Max. | Unit | Test condition |
|-------------------------------|-----------|------|-------|------|---------------|---|
| Diode forward voltage | V_{SD} | | | 1.4 | V | $I_S=30\text{ A}$, $V_{GS}=0\text{ V}$ |
| Reverse recovery time | t_{rr} | | 131.5 | | ns | $I_S=16\text{ A}$, $di/dt=100\text{ A}/\mu\text{s}$ |
| Reverse recovery charge | Q_{rr} | | 0.8 | | μC | |
| Peak reverse recovery current | I_{rrm} | | 11.0 | | A | |

Note

- 1) Calculated continuous current based on maximum allowable junction temperature.
- 2) Repetitive rating; pulse width limited by max. junction temperature.
- 3) P_d is based on max. junction temperature, using junction-case thermal resistance.
- 4) The value of $R_{\theta JA}$ is measured with the device mounted on 1 in 2 FR-4 board with 2oz. Copper, in a still air environment with $T_a=25\text{ }^\circ\text{C}$.
- 5) $V_{DD}=100\text{ V}$, $V_{GS}=10\text{ V}$, $L=60\text{ mH}$, starting $T_j=25\text{ }^\circ\text{C}$.

Electrical Characteristics Diagrams

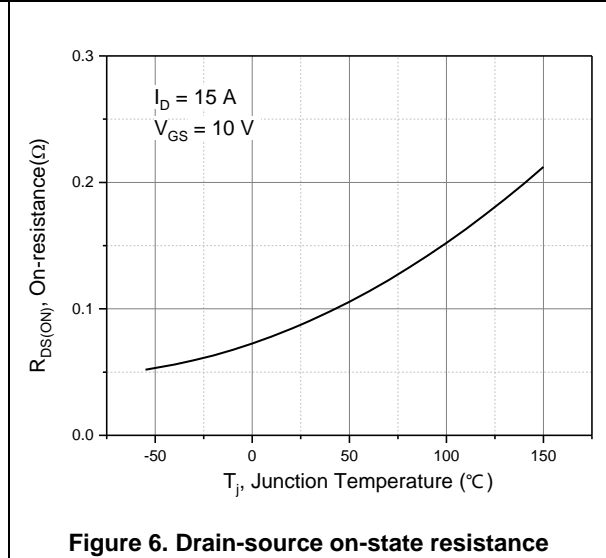
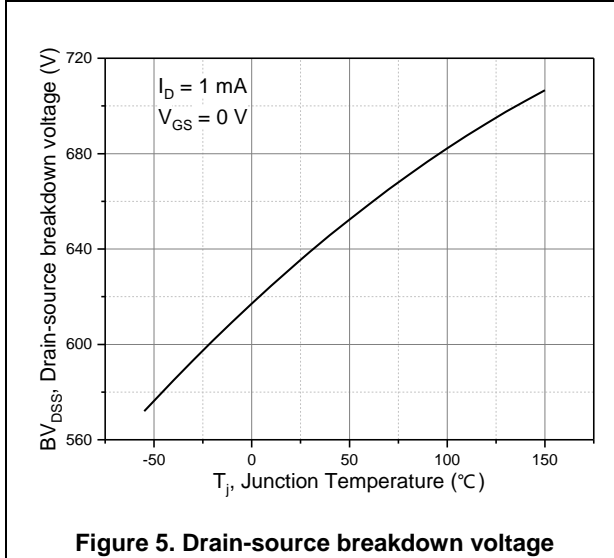
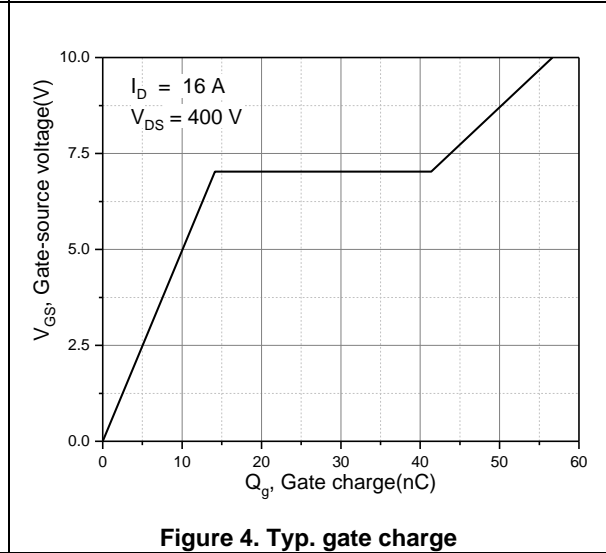
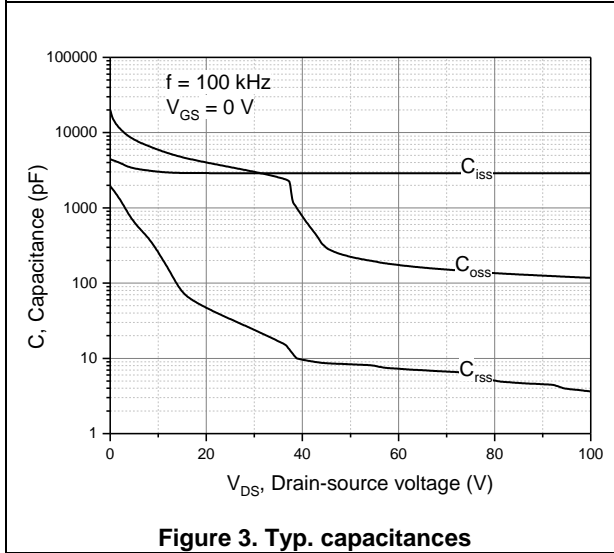
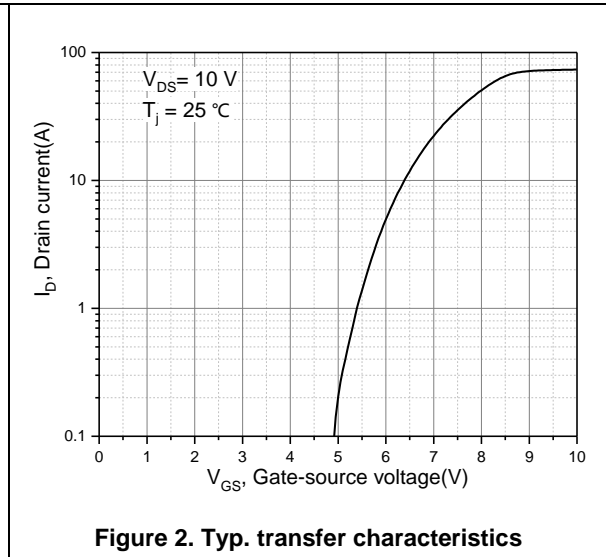
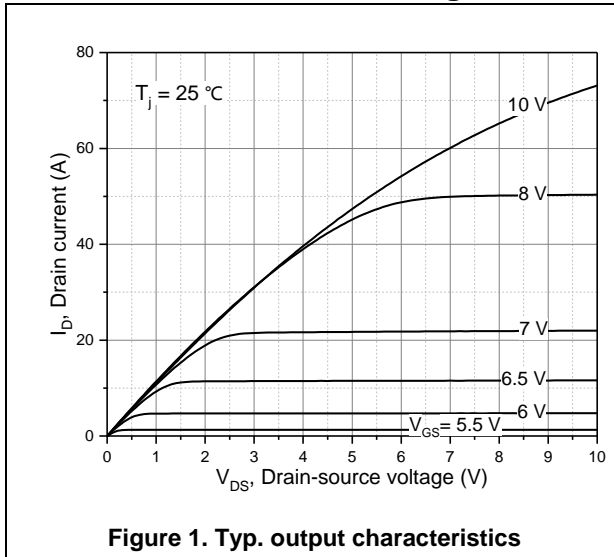

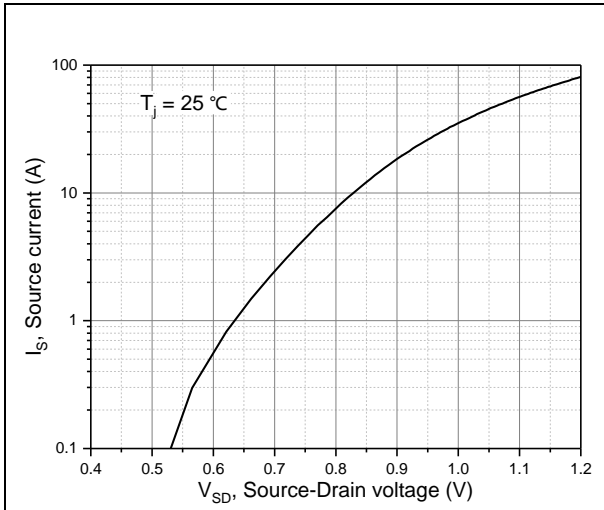

Figure 7. Forward characteristic of body diode

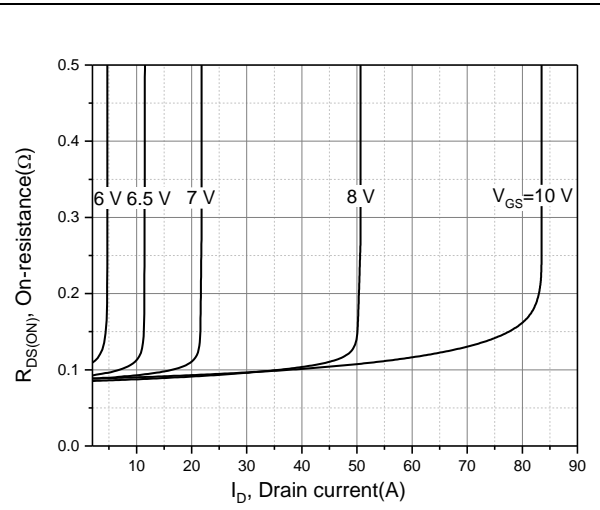

Figure 8. Drain-source on-state resistance

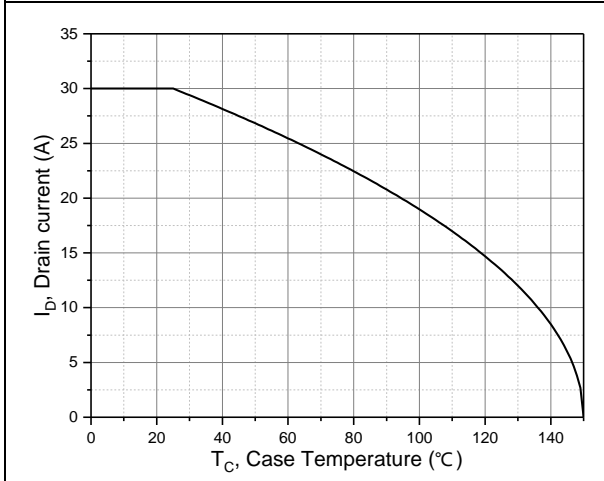

Figure 9. Drain current

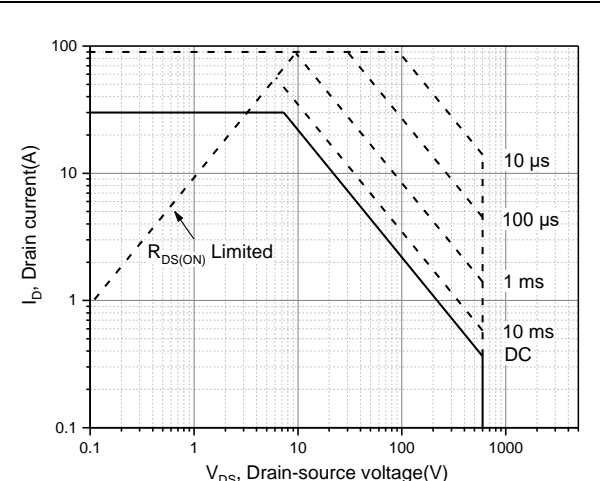

Figure 10. Safe operation area for T_C=25 °C

Test circuits and waveforms

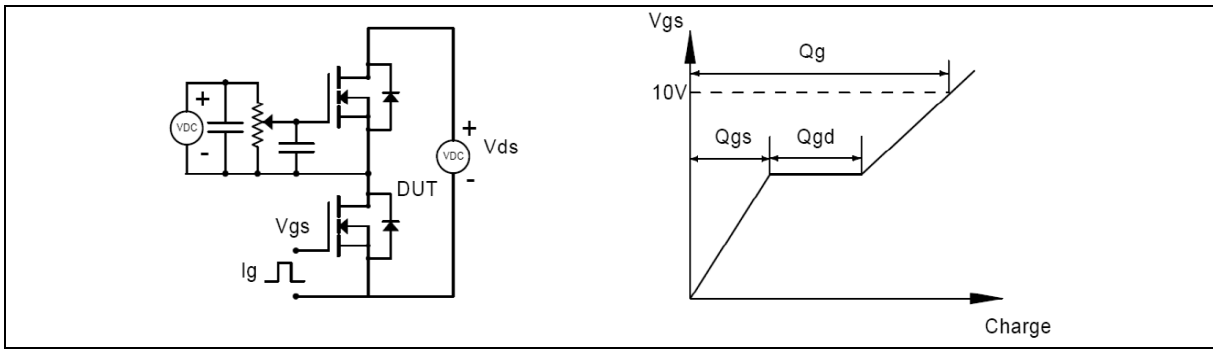

Figure 1. Gate charge test circuit & waveform

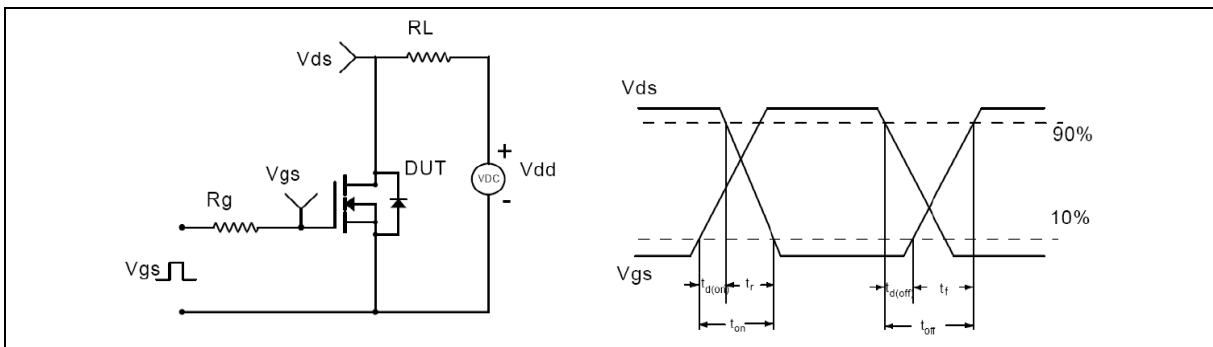

Figure 2. Switching time test circuit & waveforms



Figure 3. Unclamped inductive switching (UIS) test circuit & waveforms

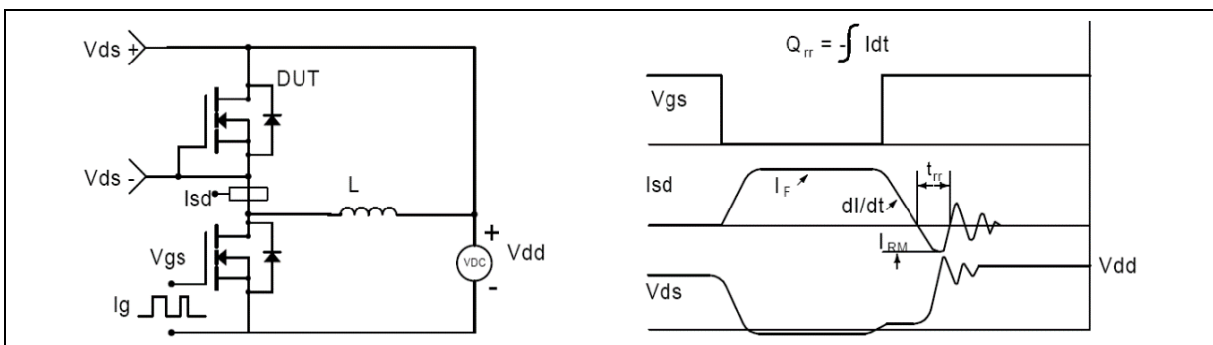
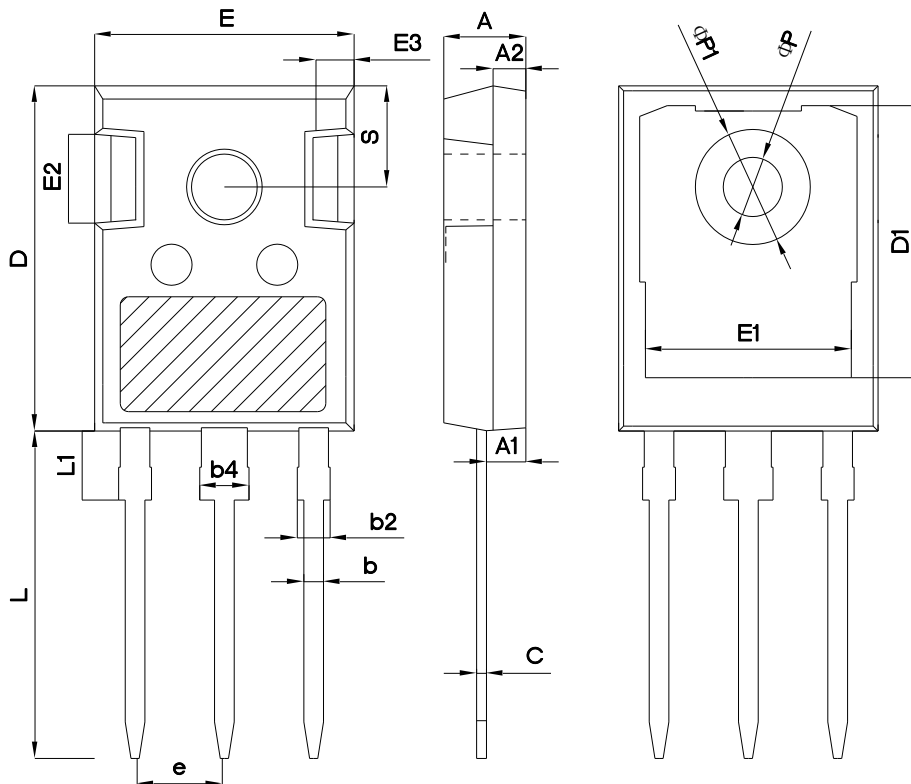

Figure 4. Diode reverse recovery test circuit & waveforms

Package Information



| Symbol | mm | | |
|--------|---------|-------|-------|
| | Min | Nom | Max |
| A | 4.80 | 5.00 | 5.20 |
| A1 | 2.21 | 2.41 | 2.59 |
| A2 | 1.85 | 2.00 | 2.15 |
| b | 1.11 | 1.21 | 1.36 |
| b2 | 1.91 | 2.01 | 2.21 |
| b4 | 2.91 | 3.01 | 3.21 |
| c | 0.51 | 0.61 | 0.75 |
| D | 20.80 | 21.00 | 21.30 |
| D1 | 16.25 | 16.55 | 16.85 |
| E | 15.50 | 15.80 | 16.10 |
| E1 | 13.00 | 13.30 | 13.60 |
| E2 | 4.80 | 5.00 | 5.20 |
| E3 | 2.30 | 2.50 | 2.70 |
| e | 5.44BSC | | |
| L | 19.82 | 19.92 | 20.22 |
| L1 | - | - | 4.30 |
| ΦP | 3.40 | 3.60 | 3.80 |
| ΦP1 | - | - | 7.30 |
| S | 6.15BSC | | |

Version 1: TO247-C outline dimension

Ordering Information

| Package Type | Units/ Tube | Tubes/ Inner Box | Units/ Inner Box | Inner Boxes/ Carton Box | Units/ Carton Box |
|--------------|-------------|------------------|------------------|-------------------------|-------------------|
| TO247-C | 30 | 11 | 330 | 6 | 1980 |

Product Information

| Product | Package | Pb Free | RoHS | Halogen Free |
|---------------|---------|---------|------|--------------|
| OSG60R108HSZF | TO247 | yes | yes | yes |

Legal Disclaimer

The information given in this document shall in no event be regarded as a guarantee of conditions or characteristics. With respect to any examples or hints given herein, any typical values stated herein and/or any information regarding the application of the device, Oriental Semiconductor hereby disclaims any and all warranties and liabilities of any kind, including without limitation, warranties of non-infringement of intellectual property rights of any third party.

For further information on technology, delivery terms and conditions and prices, please contact the Oriental Semiconductor sales representatives (www.orientalsemi.com).

© Oriental Semiconductor Co.,Ltd. All Rights Reserved 